

Simple

Datenblatt 1



Standard Anschlusstypen:

A ↓ 480÷1920:

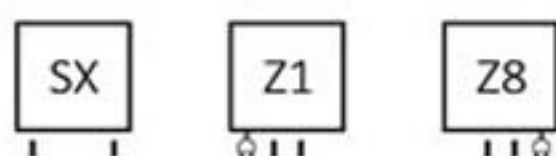

Weitere mögliche Anschlusstypen:

A ↓ 480÷1920:

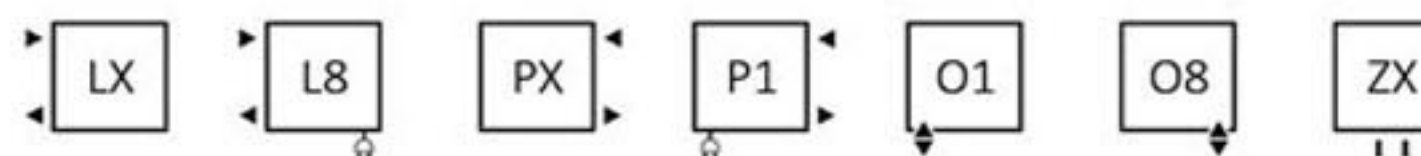

A ↓ 720÷1920:

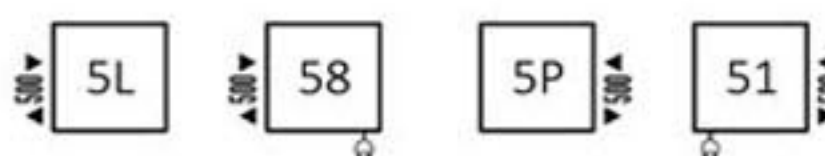

Technische Daten:

Betriebsdruck: 1000 kPa Maximale Betriebstemperatur: 95°C

A ↓ [mm]	B ↔ [mm]	C1 [mm]	C2 [mm]	75/65/20°C [W]	55/45/20°C [W]	☺ [W]	D [mm]	E [mm]	F [mm]	H [dm³]	📏 [kg]
Pulverlack											
480	500	50	470	173	100	200	470	240	120	1,96	3,84
600	500	50	470	217	123	200	470	360	120	2,45	4,74
720	500	50	470	262	145	300	470	480	120	2,94	5,64
840	500	50	470	306	167	300	470	600	120	3,43	6,54
960	500	50	470	351	189	400	470	720	120	3,92	7,43
1080	500	50	470	396	211	400	470	840	120	4,41	8,33
1200	500	50	470	440	234	400	470	960	120	4,90	9,23
1440	500	50	470	529	271	600	470	1200	120	5,89	11,03
1680	500	50	470	618	308	600	470	1440	120	6,87	12,83
1920	500	50	470	707	343	800	470	1680	120	7,85	14,63
Galvanische Oberfläche											
480	500	50	470	121	70	120	470	240	120	1,96	3,72
600	500	50	470	152	86	120	470	360	120	2,45	4,58
720	500	50	470	183	102	200	470	480	120	2,94	5,45
840	500	50	470	214	117	200	470	600	120	3,43	6,32
960	500	50	470	246	132	300	470	720	120	3,92	7,19
1080	500	50	470	277	148	300	470	840	120	4,41	8,06
1200	500	50	470	308	164	300	470	960	120	4,90	8,93
1440	500	50	470	370	190	400	470	1200	120	5,89	10,67
1680	500	50	470	433	216	400	470	1440	120	6,87	12,40

Simple

Datenblatt 2



Verfügbare Größen:

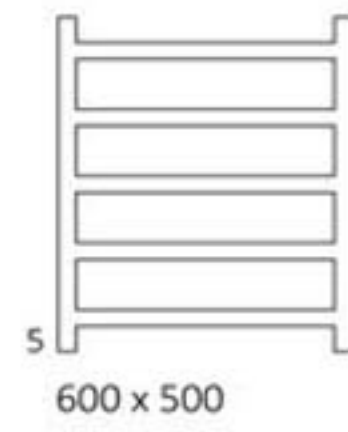
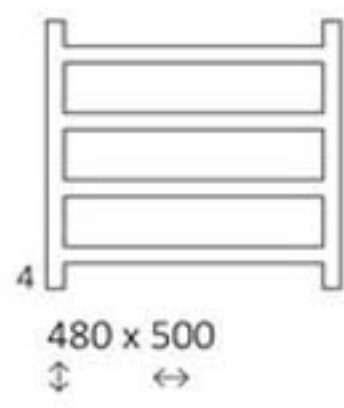

Simple Raumteiler

Datenblatt



Standard Anschlusstypen:



Weitere mögliche Anschlusstypen:

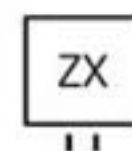

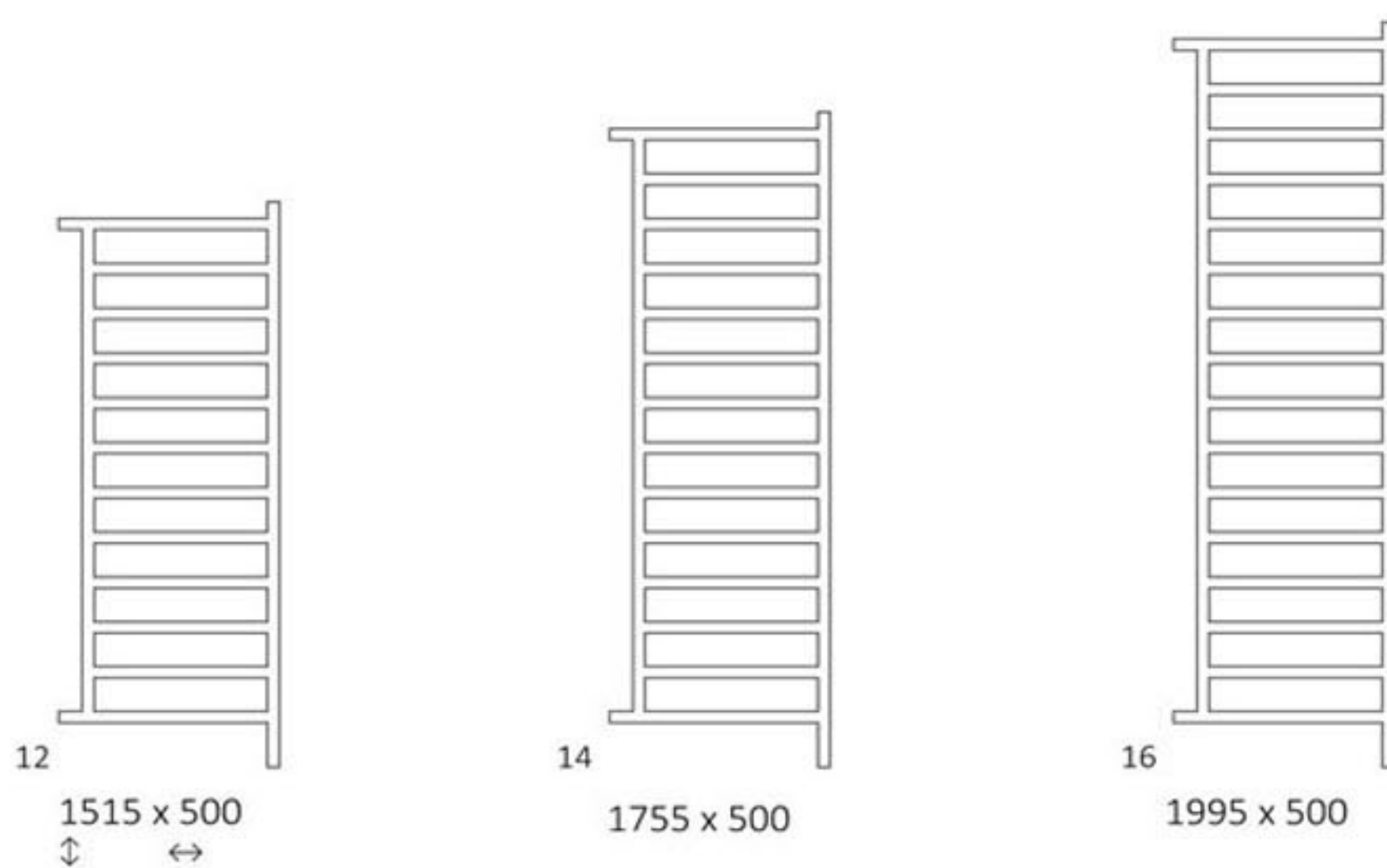

Verfügbare Größen:



Technische Daten:

Betriebsdruck: 1000 kPa

Maximale Betriebstemperatur: 95°C

A \updownarrow [mm]	B \leftrightarrow [mm]	C1 [mm]	75/65/20°C [W]	55/45/20°C [W]	 [W]	E [mm]	F [mm]	 [dm ³]	 [kg]
1515	500	50	529	271	600	1320	15	5,89	11,03
1755	500	50	618	308	600	1560	15	6,87	12,83
1995	500	50	707	343	800	1800	15	7,85	14,63

Simple

Technische Zeichnung

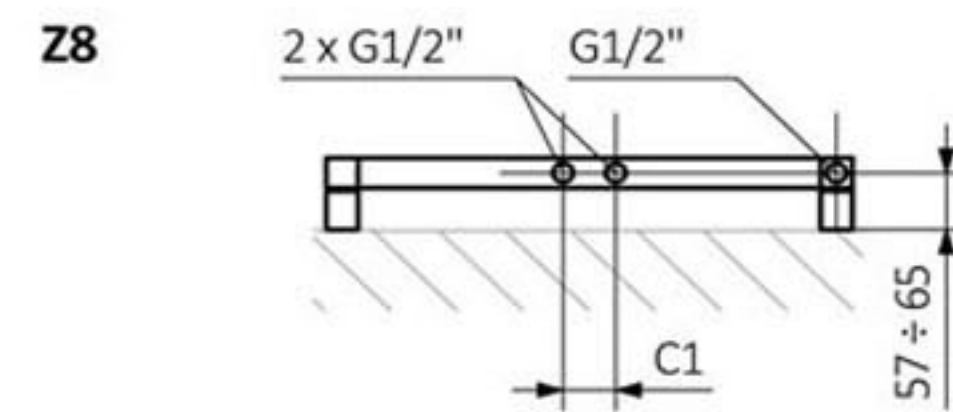
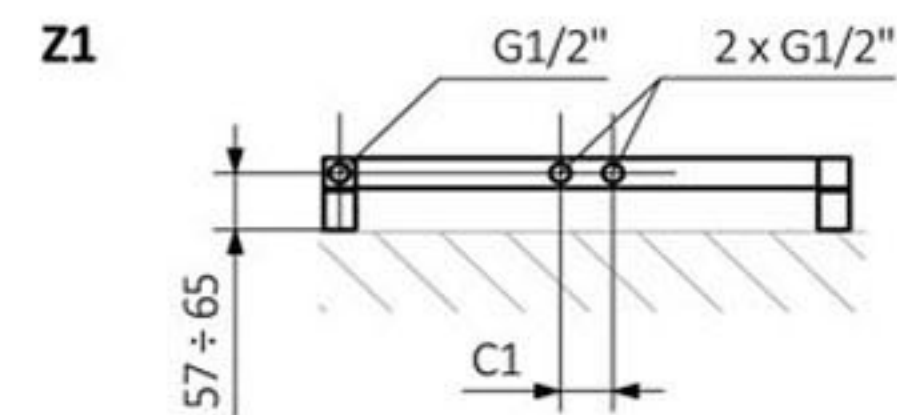
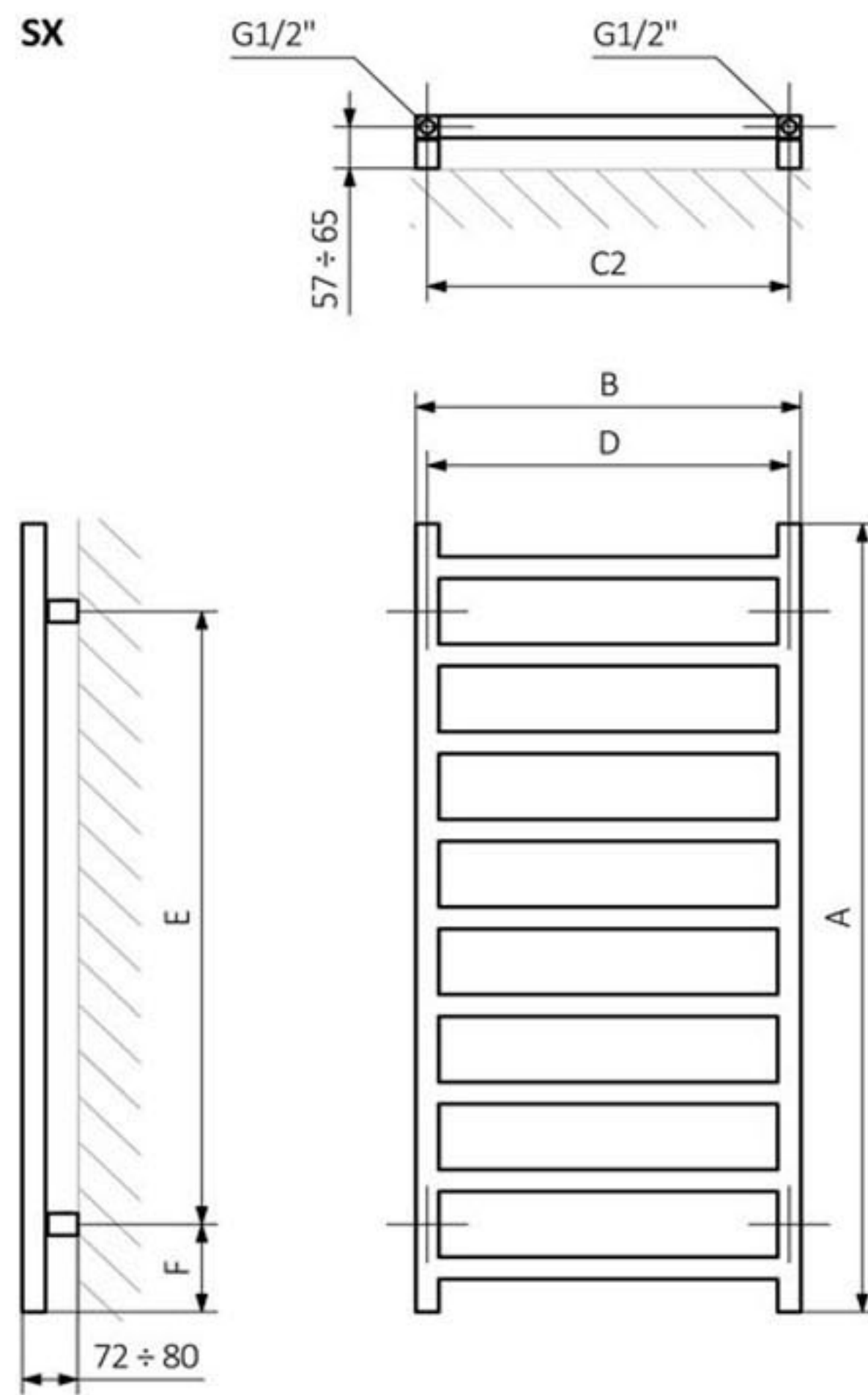

A - Höhe B - Breite C1-C5 - Anschlussabstand D - horizontaler Wandhalterungsabstand E - Vertikaler Wandhalterungsabstand
 F - Abstand von der Achse der unteren Wandhalterung bis Unterkante des Kollektors

Rohr:

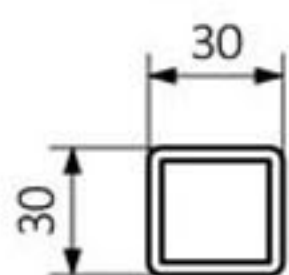

Simple Raumteiler

Technische Zeichnung

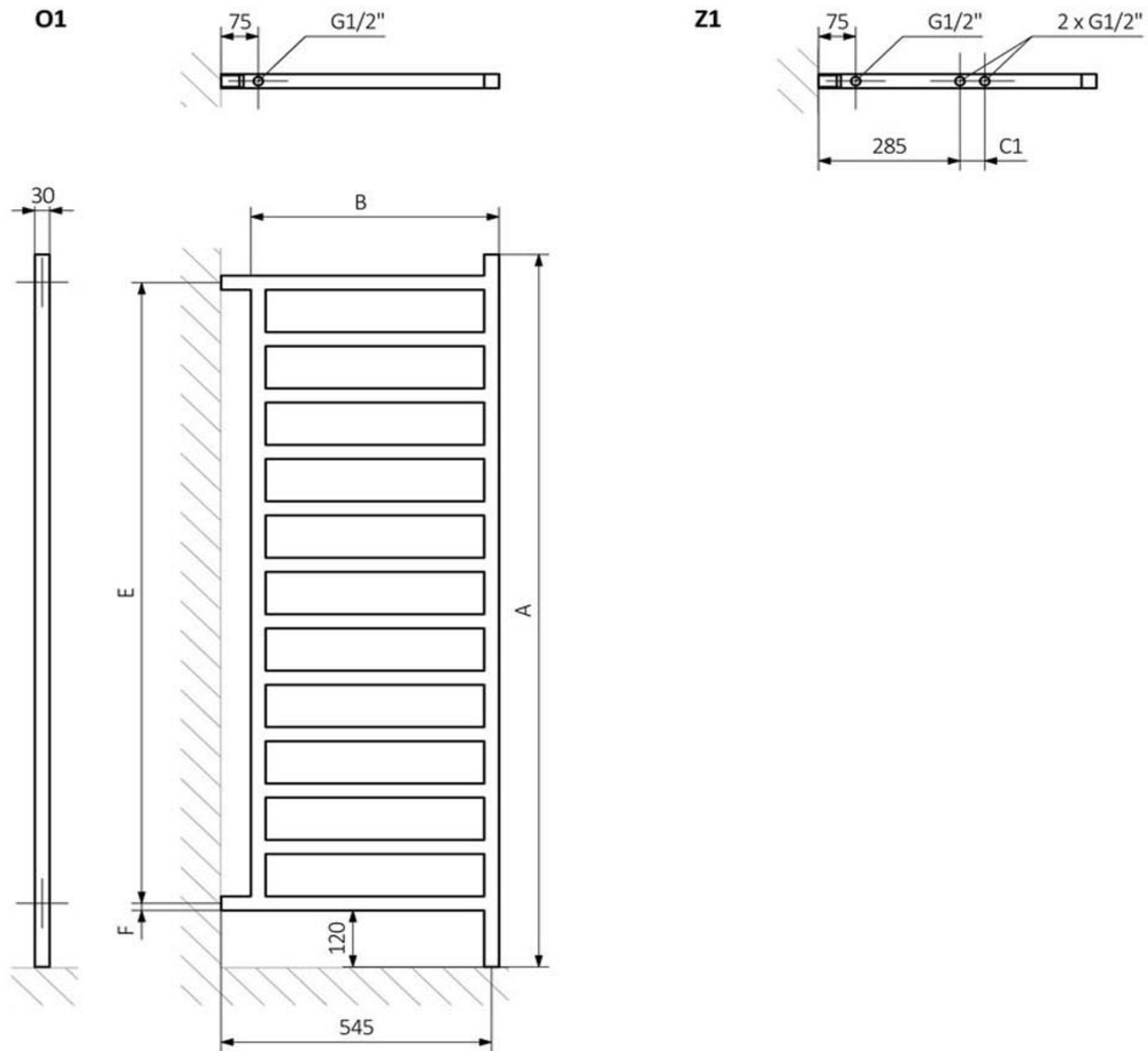

A - Höhe B - Breite C1-C5 - Anschlussabstand D - horizontaler Wandhalterungsabstand E - Vertikaler Wandhalterungsabstand
 F - Abstand von der Achse der unteren Wandhalterung bis Unterkante des Kollektors

Rohr:

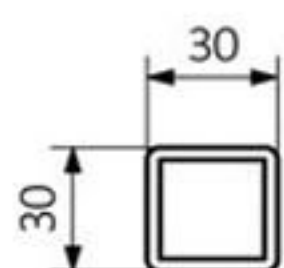

Simple

Preisliste



Modell	Höhe mm.	Breite mm.	Farbe RAL Farbpalette	Premium Farbe	Elektrisch mit Heizparone		Elektrisch mit Heizparone		Elektrisch mit Heizparone	
					Chrom	DRY / MEG / MOA Farbe	DRY / MEG / MOA Premium Farbe	DRY / MEG / MOA Chrom		
Simple	480	500	319 €	399 €	541 €	404 €		484 €		626 €
Simple	600	500	371 €	464 €	626 €	456 €		549 €		711 €
Simple	720	500	398 €	498 €	700 €	483 €		583 €		785 €
Simple	840	500	425 €	531 €	796 €	510 €		616 €		881 €
Simple	960	500	452 €	565 €	883 €	537 €		650 €		968 €
Simple	1080	500	478 €	597 €	969 €	563 €		682 €		1.054 €
Simple	1200	500	531 €	664 €	1.055 €	616 €		749 €		1.140 €
Simple	1440	500	584 €	730 €	1.265 €	669 €		815 €		1.350 €
Simple	1680	500	690 €	862 €	1.423 €	775 €		947 €		1.508 €
Simple	1920	500	743 €	929 €		828 €		1.014 €		
Simple Raumteile	1515	500	724 €	904 €		809 €		989 €		
Simple Raumteile	1755	500	779 €	974 €		864 €		1.059 €		
Simple Raumteile	1995	500	835 €	1.043 €		920 €		1.128 €		

Inkl. 19% MwSt.

zuzüglich 15,00 € Versandkosten.

Gewährleistung: 5 Jahre

Anschlussmöglichkeiten: siehe Datenblatt

Lieferzeit ca. 6 Wochen ab Zahlungseingang

Bei Bestellungen oder Nachfragen, schreiben Sie uns
eine Mail an: info@badheizkoerper-berlin.de

Badheizkörper-Berlin

Gerlinger Str. 34

12349 Berlin

Tel.: +49 (30) 658 30975

Mobil: +49 (177) 248 63 14

info@badheizkoerper-berlin.de

www.badheizkoerper-berlin.de